

Encoder Renishaw Vionic - Test Bench

Dehaeze Thomas

February 10, 2021

Contents

1	Expected Performances	3
2	Encoder Model	5
3	Noise Measurement	6
3.1	Test Bench	6
3.2	Thermal drifts	6
3.3	Time Domain signals	6
3.4	Noise Spectral Density	6
3.5	Noise Model	6
3.6	Validity of the noise model	8
4	Linearity Measurement	9
4.1	Test Bench	9
4.2	Results	9

Note

You can find below the documentation of:

- [Vionic Encoder](#)
- [Linear Scale](#)

In this document, we wish to characterize the performances of the encoder measurement system. In particular, we would like to measure:

- the measurement noise
- the linearity of the sensor
- the bandwidth of the sensor

This document is structured as follow:

- Section 1: the expected performance of the Vionic encoder system are described
- Section 2: a simple model of the encoder is developed
- Section 3: the noise of the encoder is measured and a model of the noise is identified
- Section 4: the linearity of the sensor is estimated

1 Expected Performances

The Vionic encoder is shown in Figure 1.1.



Figure 1.1: Picture of the Vionic Encoder

From the Renishaw [website](#):

The VIONiC encoder features the third generation of Renishaw's unique filtering optics that average the contributions from many scale periods and effectively filter out non-periodic features such as dirt. The nominally square-wave scale pattern is also filtered to leave a pure sinusoidal fringe field at the detector. Here, a multiple finger structure is employed, fine enough to produce photocurrents in the form of four symmetrically phased signals. These are combined to remove DC components and produce sine and cosine signal outputs with high spectral purity and low offset while maintaining **bandwidth to beyond 500 kHz**.

Fully integrated advanced dynamic signal conditioning, Auto Gain, Auto Balance and Auto Offset Controls combine to ensure **ultra-low Sub-Divisional Error (SDE) of typically $< \pm 15 \text{ nm}$** .

This evolution of filtering optics, combined with carefully-selected electronics, provide incremental signals with wide bandwidth achieving a maximum speed of 12 m/s with the lowest positional jitter (noise) of any encoder in its class. Interpolation is within the readhead, with fine resolution versions being further augmented by additional noise-reducing electronics to achieve **jitter of just 1.6 nm RMS**.

The expected interpolation errors (non-linearity) is shown in Figure 1.2.

The characteristics as advertise in the manual as well as our specifications are shown in Table 1.1.

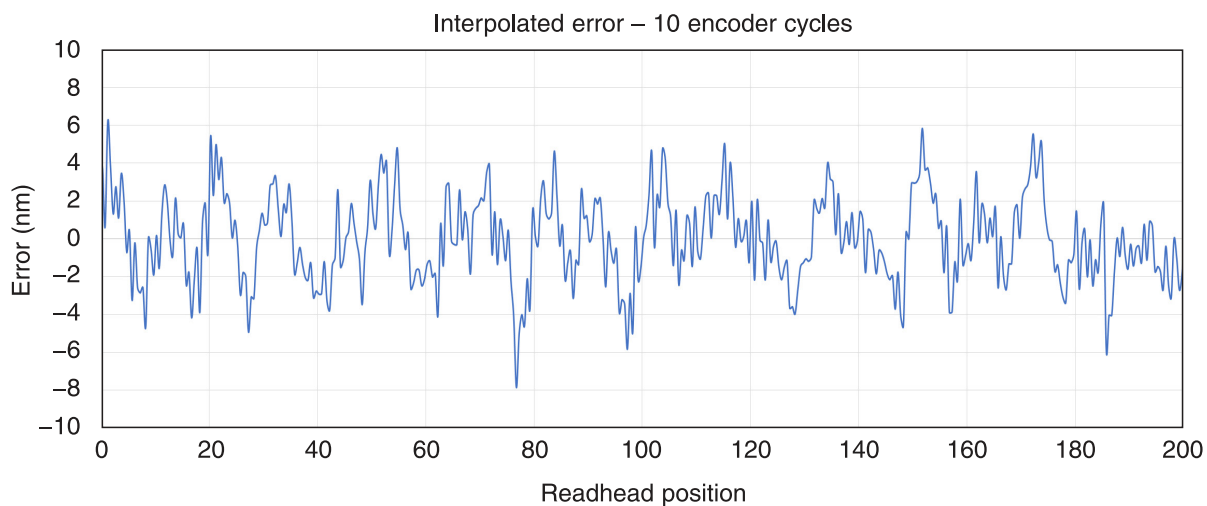

Figure 1.2: Expected interpolation errors for the Vionic Encoder

Table 1.1: Characteristics of the Vionic compared with the specifications

Characteristics	Manual	Specification
Time Delay		< 0.5 ms
Bandwidth	> 500 kHz	> 5 kHz
Noise	< 1.6 nm rms	< 50 nm rms
Linearity	< +/- 15 nm	
Range	Ruler length	> 200 um

2 Encoder Model

The Encoder is characterized by its dynamics $G_m(s)$ from the “true” displacement y to measured displacement y_m . Ideally, this dynamics is constant over a wide frequency band with very small phase drop.

It is also characterized by its measurement noise n that can be described by its Power Spectral Density (PSD) $\Gamma_n(\omega)$.

The model of the encoder is shown in Figure 2.1.

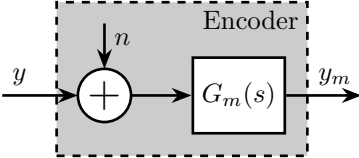
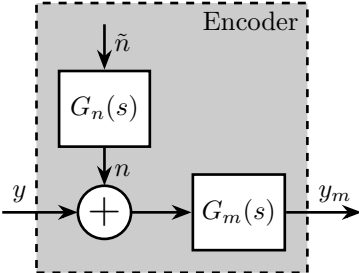

Figure 2.1: Model of the Encoder

We can also use a transfer function $G_n(s)$ to shape a noise \tilde{n} with unity ASD as shown in Figure 1.2.



3 Noise Measurement

3.1 Test Bench

To measure the noise n of the encoder, one can rigidly fix the head and the ruler together such that no motion should be measured. Then, the measured signal y_m corresponds to the noise n .

3.2 Thermal drifts

- picture of the setup
- long thermal drifts
- once stabilize, look at the noise
- compute low frequency ASD (may still be thermal drifts of the mechanics and not noise)

3.3 Time Domain signals

First we load the data. The raw measured data as well as the low pass filtered data (using a first order low pass filter with a cut-off at 10Hz) are shown in Figure 3.1.

The time domain data for all the encoders are compared in Figure 3.2.

3.4 Noise Spectral Density

The amplitude spectral density is computed and shown in Figure 3.3.

3.5 Noise Model

Let's create a transfer function that approximate the measured noise of the encoder.

```
Gn_e = 1.8e-11/(1 + s/2/pi/1e4);
```

Matlab

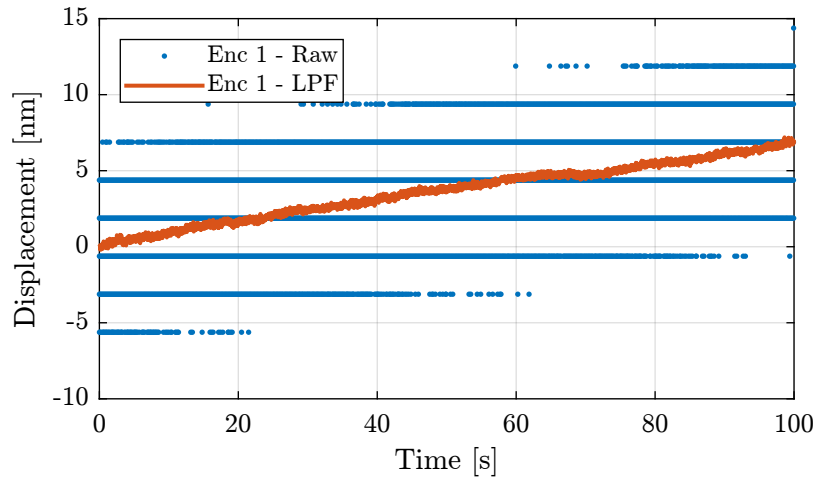

Figure 3.1: Time domain measurement (raw data and low pass filtered data with first order 10Hz LPF)

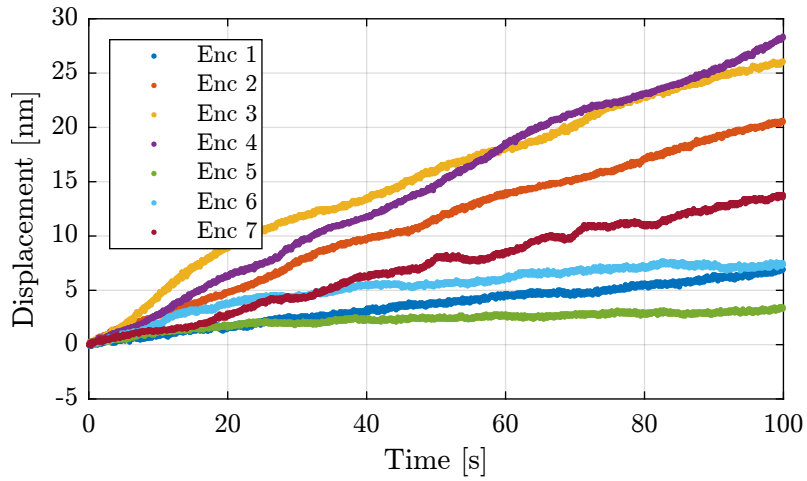

Figure 3.2: Comparison of the time domain measurement

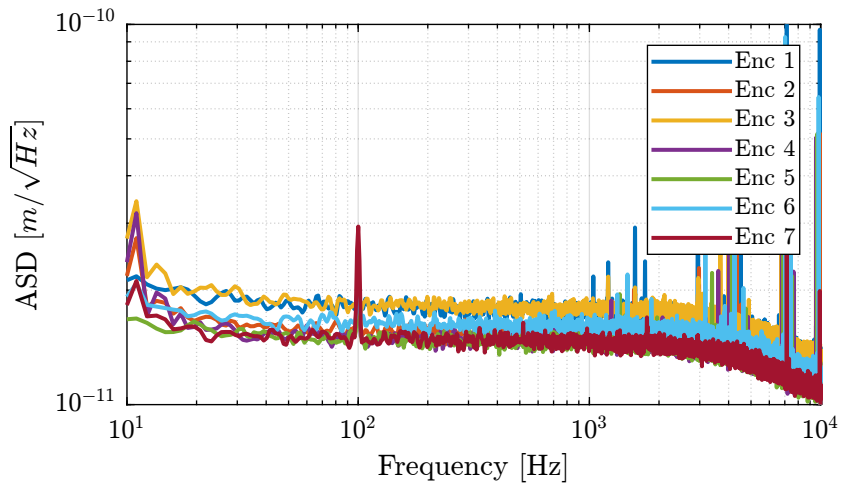

Figure 3.3: Amplitude Spectral Density of the measured signal

The amplitude of the transfer function and the measured ASD are shown in Figure 3.4.

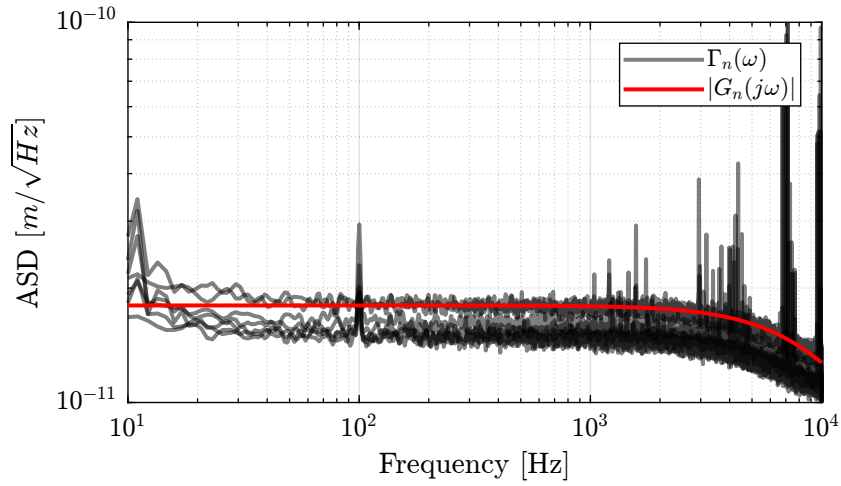

Figure 3.4: Measured ASD of the noise and modeled one

3.6 Validity of the noise model

The cumulative amplitude spectrum is now computed and shown in Figure 3.5.

We can see that the Root Mean Square value of the measurement noise is $\approx 1.6 \text{ nm}$ as advertise in the datasheet.

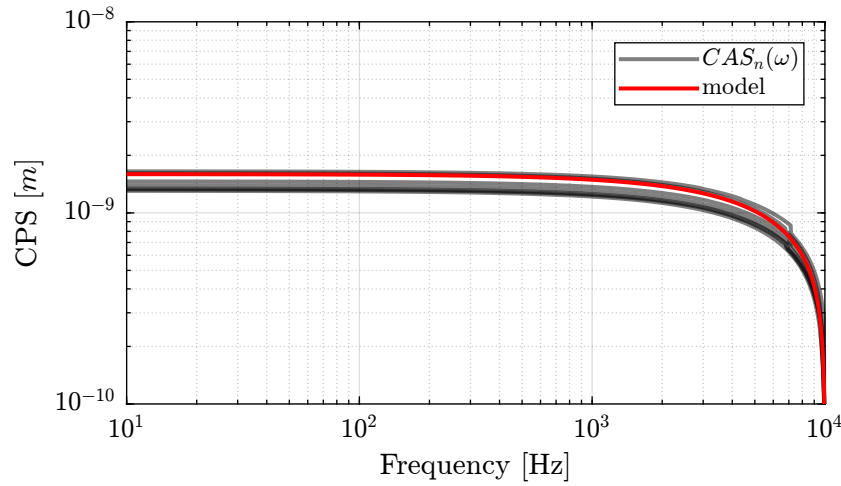

Figure 3.5: Measured CAS of the noise and modeled one

4 Linearity Measurement

4.1 Test Bench

In order to measure the linearity, we have to compare the measured displacement with a reference sensor with a known linearity. An interferometer or capacitive sensor should work fine. An actuator should also be there so impose a displacement.

One idea is to use the test-bench shown in Figure 4.1.

The APA300ML is used to excite the mass in a broad bandwidth. The motion is measured at the same time by the Vionic Encoder and by an interferometer (most likely an Attocube).

As the interferometer has a very large bandwidth, we should be able to estimate the bandwidth of the encoder if it is less than the Nyquist frequency that can be around 10kHz.

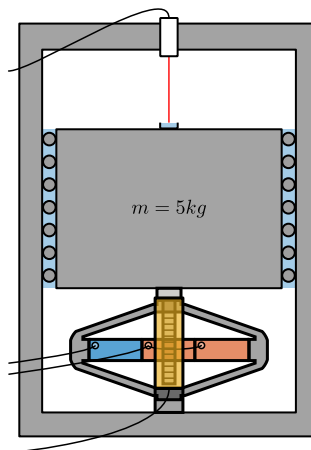

Figure 4.1: Schematic of the test bench

4.2 Results