

Optimal and Robust Sensor Fusion

Dehaeze Thomas

European Synchrotron Radiation Facility
Grenoble, France
Precision Mechatronics Laboratory
University of Liege, Belgium
thomas.dehaeze@esrf.fr

Verma Mohit

BEAMS Department
Free University of Brussels, Belgium
Precision Mechatronics Laboratory
University of Liege, Belgium
mohitverma.serc@csir.res.in

Collette Christophe

BEAMS Department
Free University of Brussels, Belgium
Precision Mechatronics Laboratory
University of Liege, Belgium
ccollett@ulb.ac.be

Abstract—Abstract text to be done

Index Terms—Complementary Filters, Sensor Fusion, H-Infinity Synthesis

I. INTRODUCTION

- Section II
- Section III
- Section IV
- Section V

II. OPTIMAL SUPER SENSOR NOISE: \mathcal{H}_2 SYNTHESIS

A. Sensor Model

Let's consider a sensor measuring a physical quantity x (Figure 1). The sensor has an internal dynamics which is here modelled with a Linear Time Invariant (LTI) system transfer function $G_i(s)$.

The noise of sensor can be described by the Power Spectral Density (PSD) $\Phi_{\tilde{n}_i}(\omega)$.

This is approximated by shaping a white noise with unitary PSD \tilde{n}_i (2) with a LTI transfer function $N_i(s)$:

$$\begin{aligned} \Phi_{\tilde{n}_i}(\omega) &= |N_i(j\omega)|^2 \Phi_{\tilde{n}_i}(\omega) \\ &= |N_i(j\omega)|^2 \end{aligned} \quad (1)$$

$$\Phi_{\tilde{n}_i}(\omega) = 1 \quad (2)$$

The output of the sensor v_i :

$$v_i = (G_i) x + (G_i N_i) \tilde{n}_i \quad (3)$$

In order to obtain an estimate \hat{x}_i of x , a model \hat{G}_i of the (true) sensor dynamics G_i is inverted and applied at the output (Figure 1):

$$\hat{x}_i = \left(\hat{G}_i^{-1} G_i \right) x + \left(\hat{G}_i^{-1} G_i N_i \right) \tilde{n}_i \quad (4)$$

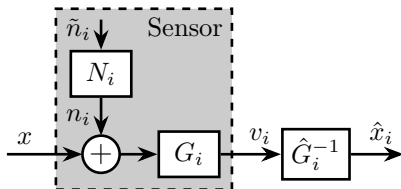

Fig. 1. Sensor Model

B. Sensor Fusion Architecture

Let's now consider two sensors measuring the same physical quantity x but with different dynamics (G_1, G_2) and noise characteristics (N_1, N_2) (Figure 2).

The noise sources \tilde{n}_1 and \tilde{n}_2 are considered to be uncorrelated.

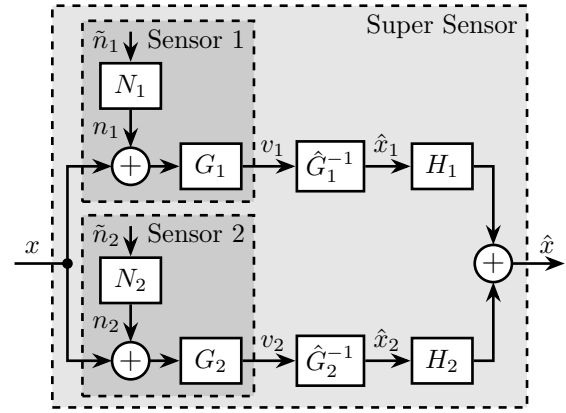

Fig. 2. Sensor Fusion Architecture with sensor noise

The output of both sensors (v_1, v_2) are then passed through the inverse of the sensor model to obtained two estimates (\hat{x}_1, \hat{x}_2) of x . These two estimates are then filtered out by two filters H_1 and H_2 and summed to gives the super sensor estimate \hat{x} .

$$\begin{aligned} \hat{x} &= \left(H_1 \hat{G}_1^{-1} G_1 + H_2 \hat{G}_2^{-1} G_2 \right) x \\ &\quad + \left(H_1 \hat{G}_1^{-1} G_1 N_1 \right) \tilde{n}_1 + \left(H_2 \hat{G}_2^{-1} G_2 N_2 \right) \tilde{n}_2 \end{aligned} \quad (5)$$

Suppose the sensor dynamical model \hat{G}_i is perfect:

$$\hat{G}_i = G_i \quad (6)$$

We considered here complementary filters:

$$H_1(s) + H_2(s) = 1 \quad (7)$$

In such case, the super sensor estimate \hat{x} is equal to x plus the noise of the individual sensors filtered out by the complementary filters:

$$\hat{x} = x + (H_1 N_1) \tilde{n}_1 + (H_2 N_2) \tilde{n}_2 \quad (8)$$

C. Super Sensor Noise

Let's note n the super sensor noise.

$$n = (H_1 N_1) \tilde{n}_1 + (H_2 N_2) \tilde{n}_2 \quad (9)$$

As the noise of both sensors are considered to be uncorrelated, the PSD of the super sensor noise is computed as follow:

$$\Phi_n(\omega) = |H_1 N_1|^2 + |H_2 N_2|^2 \quad (10)$$

It is clear that the PSD of the super sensor depends on the norm of the complementary filters.

D. \mathcal{H}_2 Synthesis of Complementary Filters

The goal is to design $H_1(s)$ and $H_2(s)$ such that the effect of the noise sources \tilde{n}_1 and \tilde{n}_2 has the smallest possible effect on the noise n of the estimation \hat{x} .

And the goal is the minimize the Root Mean Square (RMS) value of n :

$$\sigma_n = \sqrt{\int_0^\infty \Phi_n(\omega) d\omega} = \left\| \begin{bmatrix} H_1 N_1 \\ H_2 N_2 \end{bmatrix} \right\|_2 \quad (11)$$

Thus, the goal is to design $H_1(s)$ and $H_2(s)$ such that $H_1(s) + H_2(s) = 1$ and such that σ_n is minimized.

This can be cast into an \mathcal{H}_2 synthesis problem by considering the following generalized plant (also represented in Figure 3):

$$\begin{pmatrix} z_1 \\ z_2 \\ v \end{pmatrix} = \underbrace{\begin{bmatrix} N_1 & -N_1 \\ 0 & N_2 \\ 1 & 0 \end{bmatrix}}_{P_{\mathcal{H}_2}} \begin{pmatrix} w \\ u \end{pmatrix} \quad (12)$$

Applying the \mathcal{H}_2 synthesis on $P_{\mathcal{H}_2}$ will generate a filter $H_2(s)$ such that the \mathcal{H}_2 norm from w to (z_1, z_2) is minimized:

$$\left\| \begin{bmatrix} z_1/w \\ z_2/w \end{bmatrix} \right\|_2 = \left\| \begin{bmatrix} N_1(1 - H_2) \\ N_2 H_2 \end{bmatrix} \right\|_2 \quad (13)$$

The \mathcal{H}_2 norm of Eq. (13) is equals to σ_n by defining $H_1(s)$ to be the complementary filter of $H_2(s)$:

$$H_1(s) = 1 - H_2(s) \quad (14)$$

We then have that the \mathcal{H}_2 synthesis applied on $P_{\mathcal{H}_2}$ generates two complementary filters $H_1(s)$ and $H_2(s)$ such that the RMS value of super sensor noise is minimized.

E. Example

F. Robustness Problem

III. ROBUST SENSOR FUSION: \mathcal{H}_∞ SYNTHESIS

A. Representation of Sensor Dynamical Uncertainty

In Section II, the model $\hat{G}_i(s)$ of the sensor was considered to be perfect. In reality, there are always uncertainty (neglected dynamics) associated with the estimation of the sensor dynamics.

The Uncertainty on the sensor dynamics $G_i(s)$ is here modelled by (input) multiplicative uncertainty:

$$G_i(s) = \hat{G}_i(s) (1 + W_i(s) \Delta_i(s)); \quad |\Delta_i(j\omega)| < 1 \forall \omega \quad (15)$$

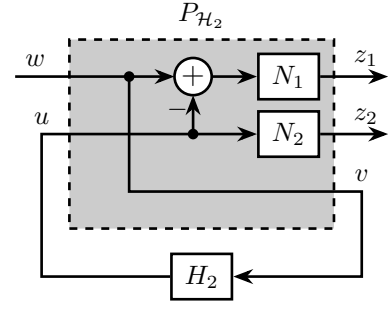

Fig. 3. Generalized plant $P_{\mathcal{H}_2}$ used for the \mathcal{H}_2 synthesis of complementary filters

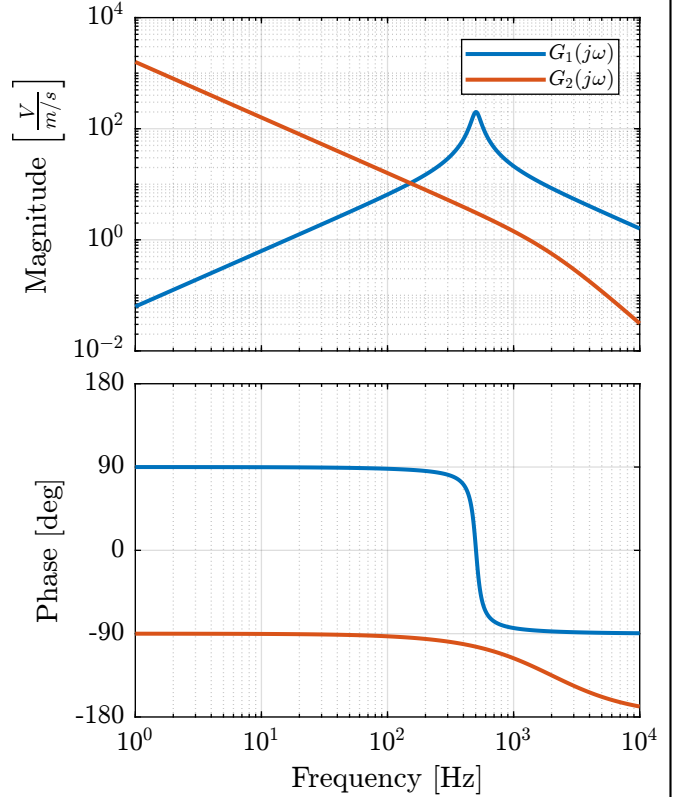

Fig. 4. Sensor nominal dynamics from the velocity of the object to the output voltage

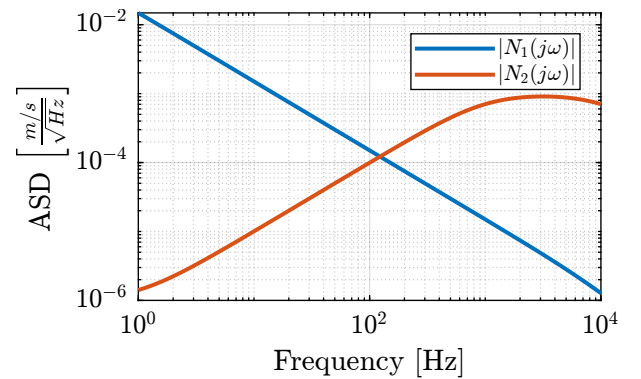

Fig. 5. Amplitude spectral density of the sensors $\sqrt{\Phi_{n_i}(\omega)} = |N_i(j\omega)|$

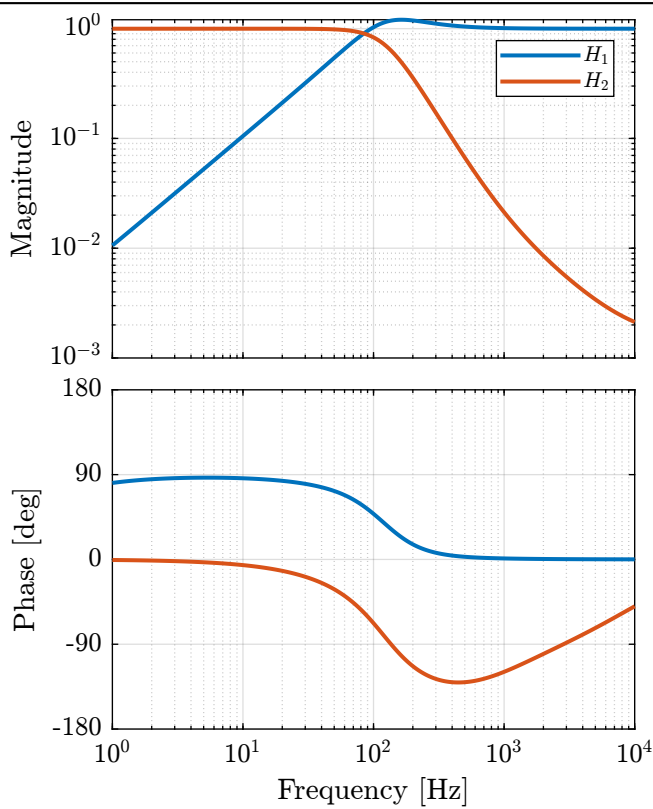

Fig. 6. Obtained complementary filters using the \mathcal{H}_2 Synthesis

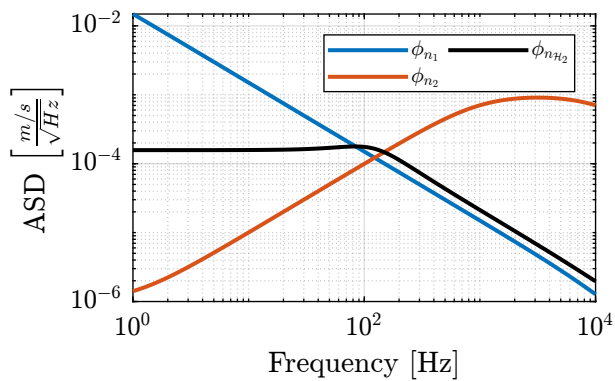

Fig. 7. Power Spectral Density of the estimated \hat{x} using the two sensors alone and using the optimally fused signal

where $\hat{G}_i(s)$ is the nominal model, W_i a weight representing the size of the uncertainty at each frequency, and Δ_i is any complex perturbation such that $\|\Delta_i\|_\infty < 1$.

The sensor can then be represented as shown in Figure 11.

B. Sensor Fusion Architecture

Let's consider the sensor fusion architecture shown in Figure 12 where the dynamical uncertainties of both sensors are included.

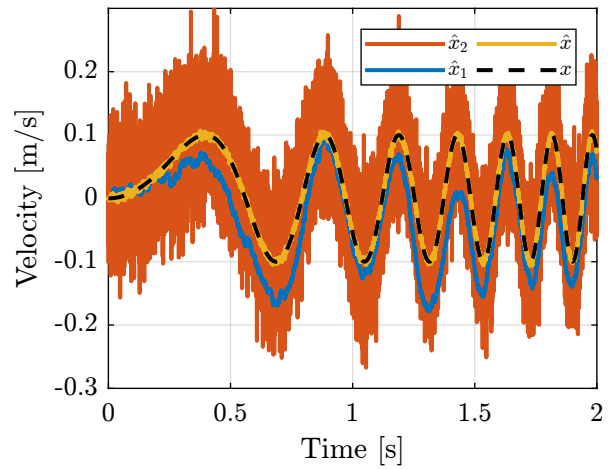

Fig. 8. Noise of individual sensors and noise of the super sensor

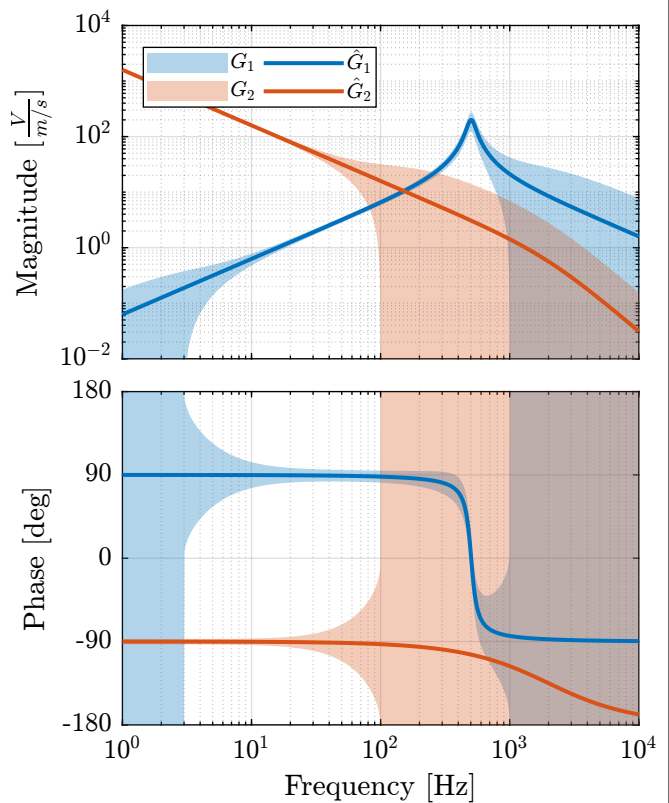

Fig. 9. Nominal Sensor Dynamics \hat{G}_i (solid lines) as well as the spread of the dynamical uncertainty (background color)

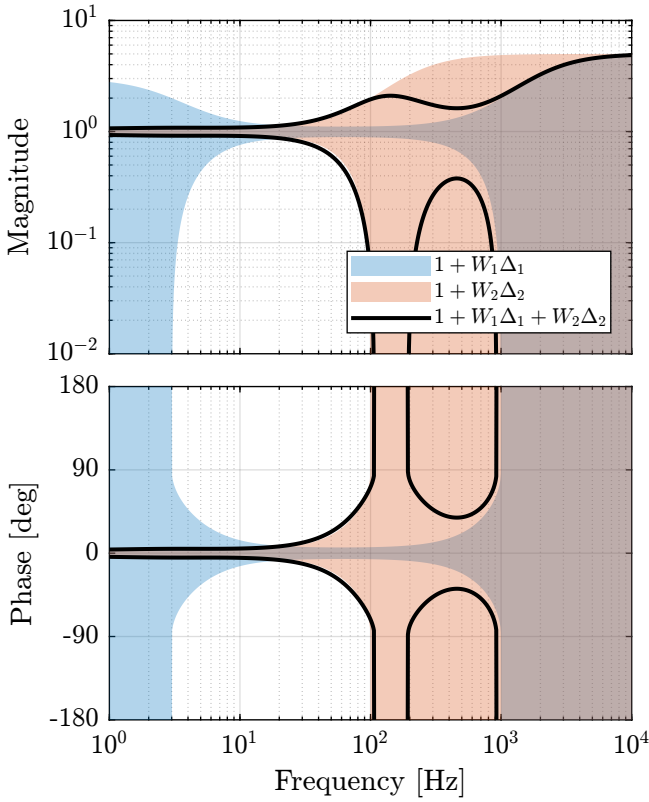

Fig. 10. Super sensor dynamical uncertainty when using the \mathcal{H}_2 Synthesis

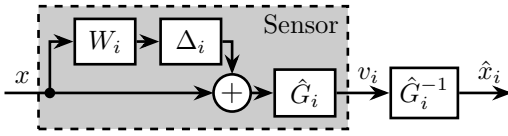

Fig. 11. Sensor Model including Dynamical Uncertainty

The super sensor estimate is then:

$$\begin{aligned}\hat{x} &= \left(H_1 \hat{G}_1^{-1} \hat{G}_1 (1 + W_1 \Delta_1) \right. \\ &\quad \left. + H_2 \hat{G}_2^{-1} \hat{G}_2 (1 + W_2 \Delta_2) \right) x \\ &= \left(H_1 (1 + W_1 \Delta_1) + H_2 (1 + W_2 \Delta_2) \right) x\end{aligned}\quad (16)$$

with Δ_i is any transfer function satisfying $\|\Delta_i\|_\infty < 1$.

As H_1 and H_2 are complementary filters, we finally have:

$$\hat{x} = (1 + H_1 W_1 \Delta_1 + H_2 W_2 \Delta_2) x, \quad \|\Delta_i\|_\infty < 1 \quad (17)$$

C. Super Sensor Dynamical Uncertainty

The uncertainty set of the transfer function from \hat{x} to x at frequency ω is bounded in the complex plane by a circle centered on 1 and with a radius equal to $|W_1(j\omega)H_1(j\omega)| + |W_2(j\omega)H_2(j\omega)|$ as shown in Figure 13.

And we can see that the dynamical uncertainty of the super sensor is equal to the sum of the individual sensor uncertainties filtered out by the complementary filters.

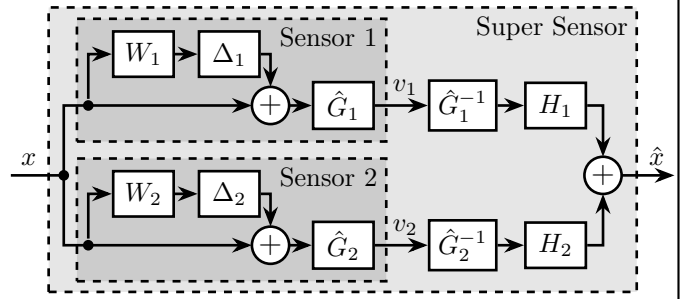

Fig. 12. Sensor Fusion Architecture with sensor model uncertainty

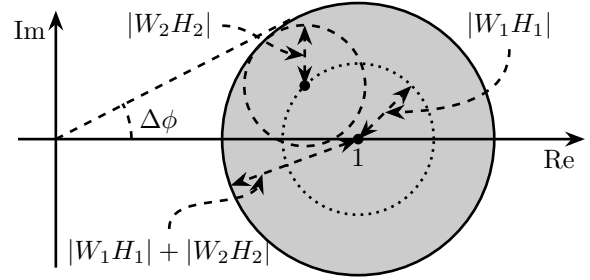

Fig. 13. Super Sensor model uncertainty displayed in the complex plane

At frequencies where $|W_i(j\omega)| > 1$ the uncertainty exceeds 100% and sensor fusion is impossible.

D. \mathcal{H}_∞ Synthesis of Complementary Filters

In order for the fusion to be “robust”, meaning no phase drop will be induced in the super sensor dynamics,

The goal is to design two complementary filters $H_1(s)$ and $H_2(s)$ such that the super sensor noise uncertainty is kept reasonably small.

To define what by “small” we mean, we use a weighting filter $W_u(s)$ such that the synthesis objective is:

$$|W_1(j\omega)H_1(j\omega)| + |W_2(j\omega)H_2(j\omega)| < \frac{1}{|W_u(j\omega)|}, \quad \forall \omega \quad (18)$$

This is actually almost equivalent as to have (within a factor $\sqrt{2}$):

$$\left\| \frac{W_u W_1 H_1}{W_u W_2 H_2} \right\|_\infty < 1 \quad (19)$$

This problem can thus be dealt with an \mathcal{H}_∞ synthesis problem by considering the following generalized plant (Figure 14):

$$\begin{pmatrix} z_1 \\ z_2 \\ v \end{pmatrix} = \underbrace{\begin{bmatrix} W_u W_1 & -W_u W_1 \\ 0 & W_u W_2 \\ 1 & 0 \end{bmatrix}}_{P_{\mathcal{H}_\infty}} \begin{pmatrix} w \\ u \end{pmatrix} \quad (20)$$

Applying the \mathcal{H}_∞ synthesis on $P_{\mathcal{H}_\infty}$ will generate a filter $H_2(s)$ such that the \mathcal{H}_∞ norm from w to (z_1, z_2) is minimized:

$$\left\| \begin{pmatrix} z_1/w \\ z_2/w \end{pmatrix} \right\|_\infty = \left\| \frac{W_u W_1 (1 - H_2)}{W_u W_2 H_2} \right\|_\infty \quad (21)$$

The \mathcal{H}_∞ norm of Eq. (21) is equals to σ_n by defining $H_1(s)$ to be the complementary filter of $H_2(s)$:

$$H_1(s) = 1 - H_2(s) \quad (22)$$

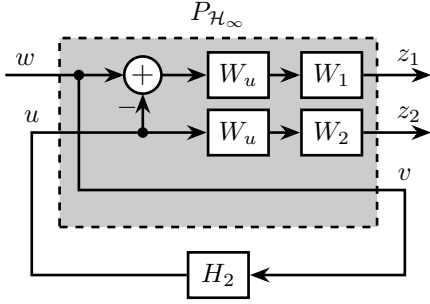

Fig. 14. Generalized plant $P_{\mathcal{H}_\infty}$ used for the \mathcal{H}_∞ synthesis of complementary filters

E. Example

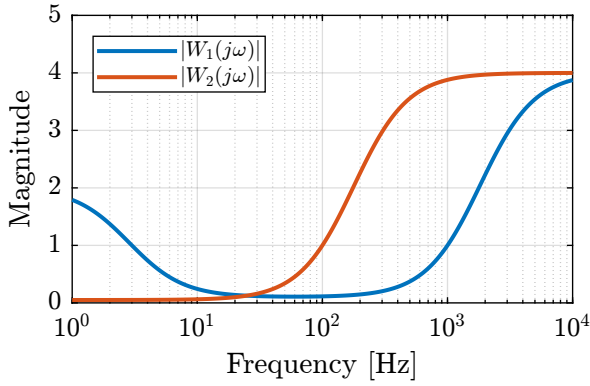

Fig. 15. Magnitude of the multiplicative uncertainty weights $|W_i(j\omega)|$

IV. OPTIMAL AND ROBUST SENSOR FUSION: MIXED $\mathcal{H}_2/\mathcal{H}_\infty$ SYNTHESIS

A. Sensor with noise and model uncertainty

We wish now to combine the two previous synthesis, that is to say

The sensors are now modelled by a white noise with unitary PSD \tilde{n}_i shaped by a LTI transfer function $N_i(s)$. The dynamical uncertainty of the sensor is modelled using multiplicative uncertainty

$$v_i = \hat{G}_i(1 + W_i\Delta_i)x + \hat{G}_i(1 + W_i\Delta_i)N_i\tilde{n}_i \quad (23)$$

Multiplying by the inverse of the nominal model of the sensor dynamics gives an estimate \hat{x}_i of x :

$$\hat{x} = (1 + W_i\Delta_i)x + (1 + W_i\Delta_i)N_i\tilde{n}_i \quad (24)$$

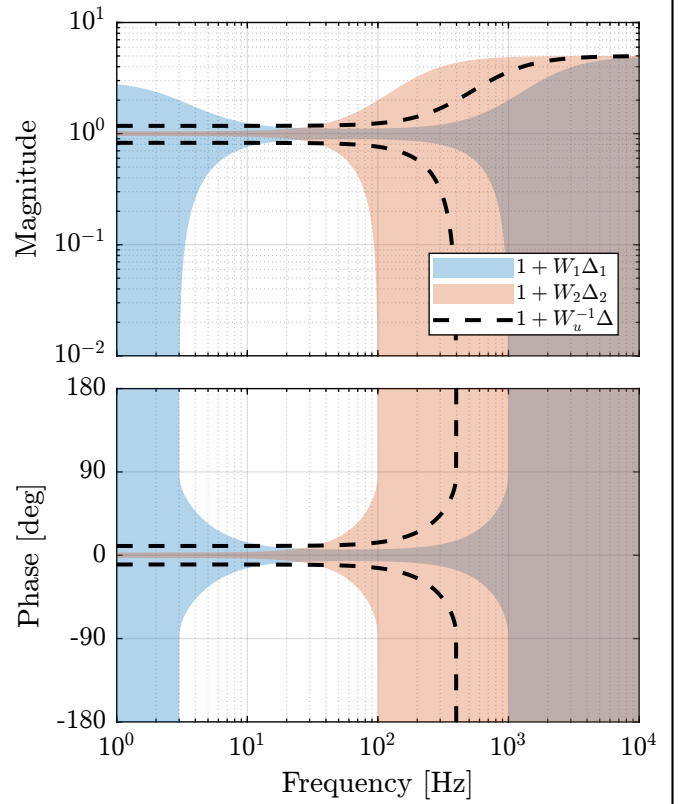

Fig. 16. Uncertainty region of the two sensors as well as the wanted maximum uncertainty of the super sensor (dashed lines)

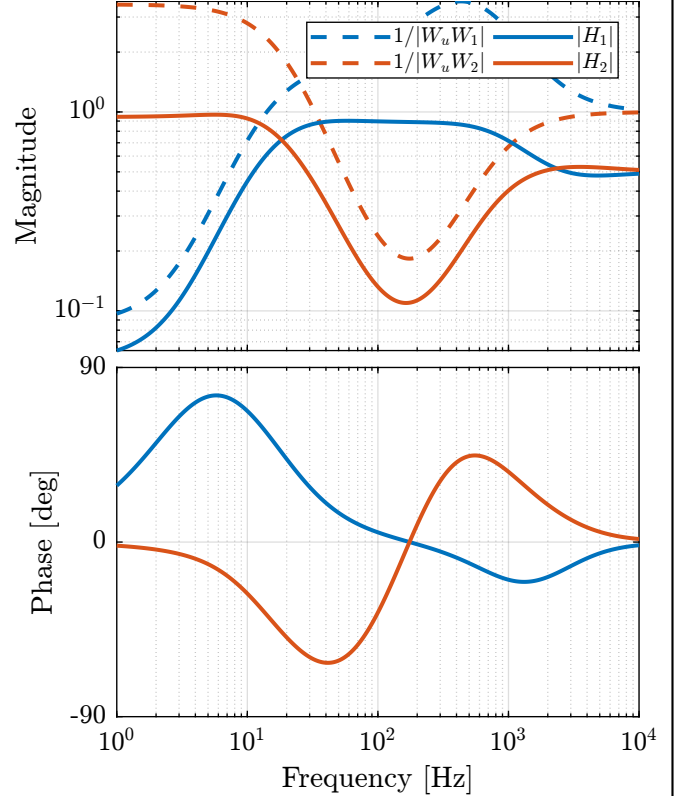

Fig. 17. Obtained complementary filters using the \mathcal{H}_∞ Synthesis

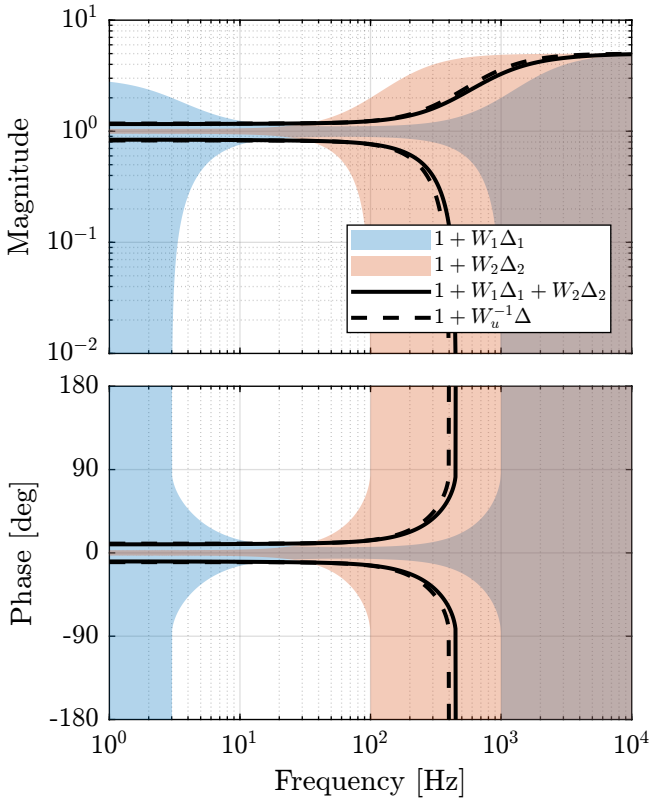

Fig. 18. Super sensor dynamical uncertainty (solid curve) when using the \mathcal{H}_∞ Synthesis

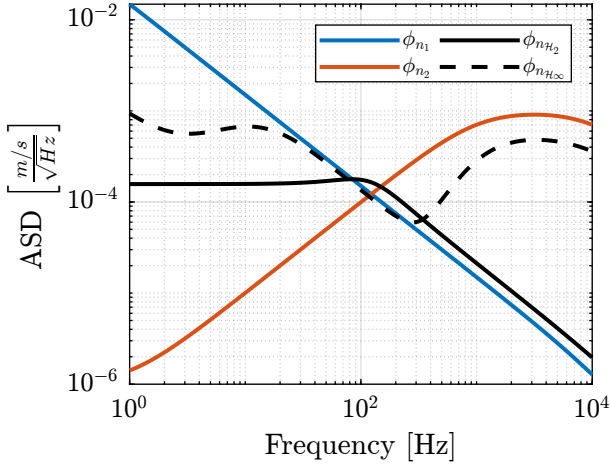

Fig. 19. Power Spectral Density of the estimated \hat{x} using the two sensors alone and using the \mathcal{H}_∞ synthesis

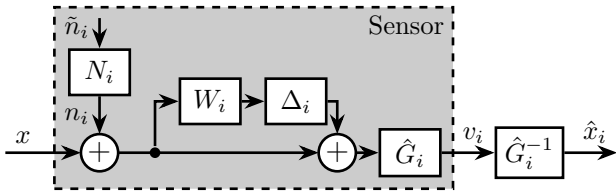

Fig. 20. Sensor Model including Noise and Dynamical Uncertainty

B. Sensor Fusion Architecture

For reason of space, the blocks \hat{G}_i and \hat{G}_i^{-1} are omitted.

$$\hat{x} = \left(H_1(1 + W_1\Delta_1) + H_2(1 + W_2\Delta_2) \right) x + \left(H_1(1 + W_1\Delta_1)N_1 \right) \tilde{n}_1 + \left(H_2(1 + W_2\Delta_2)N_2 \right) \tilde{n}_2 \quad (25)$$

$$\hat{x} = \left(1 + H_1W_1\Delta_1 + H_2W_2\Delta_2 \right) x + \left(H_1(1 + W_1\Delta_1)N_1 \right) \tilde{n}_1 + \left(H_2(1 + W_2\Delta_2)N_2 \right) \tilde{n}_2 \quad (26)$$

The estimate \hat{x} of x

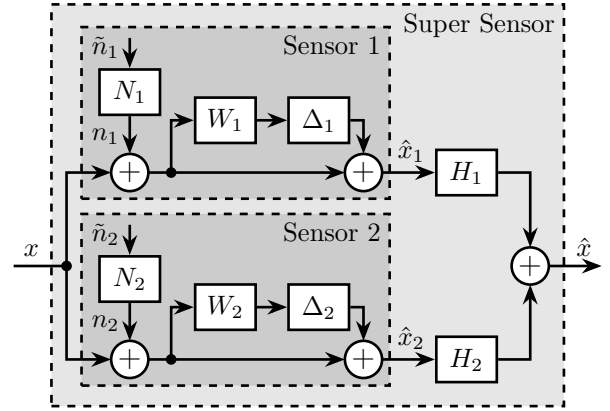

Fig. 21. Super Sensor Fusion with both sensor noise and sensor model uncertainty

C. Mixed $\mathcal{H}_2/\mathcal{H}_\infty$ Synthesis

The synthesis objective is to generate two complementary filters $H_1(s)$ and $H_2(s)$ such that the uncertainty associated with the super sensor is kept reasonably small and such that the RMS value of super sensors noise is minimized.

To specify how small we want the super sensor dynamic spread, we use a weighting filter $W_u(s)$ as was done in Section III.

This synthesis problem can be solved using the mixed $\mathcal{H}_2/\mathcal{H}_\infty$ synthesis on the following generalized plant:

$$\begin{pmatrix} z_{\infty,1} \\ z_{\infty,2} \\ z_{2,1} \\ z_{2,2} \\ v \end{pmatrix} = \underbrace{\begin{bmatrix} W_u W_1 & W_u W_1 \\ 0 & W_u W_2 \\ N_1 & N_1 \\ 0 & N_2 \\ 1 & 0 \end{bmatrix}}_{P_{\mathcal{H}_2/\mathcal{H}_\infty}} \begin{pmatrix} w \\ u \end{pmatrix} \quad (27)$$

The synthesis objective is to:

- Keep the \mathcal{H}_∞ norm from w to $(z_{\infty,1}, z_{\infty,2})$ below 1
- Minimize the \mathcal{H}_2 norm from w to $(z_{2,1}, z_{2,2})$

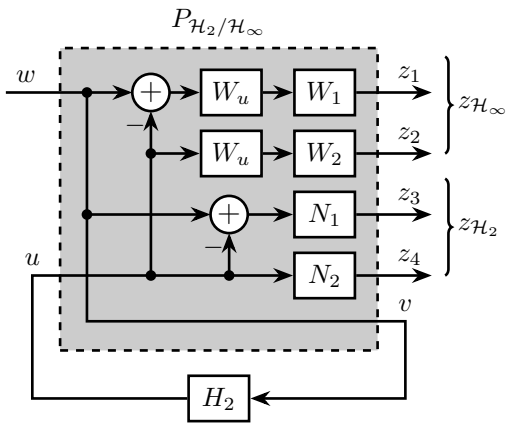

Fig. 22. Generalized plant $P_{\mathcal{H}_2/\mathcal{H}_\infty}$ used for the mixed $\mathcal{H}_2/\mathcal{H}_\infty$ synthesis of complementary filters

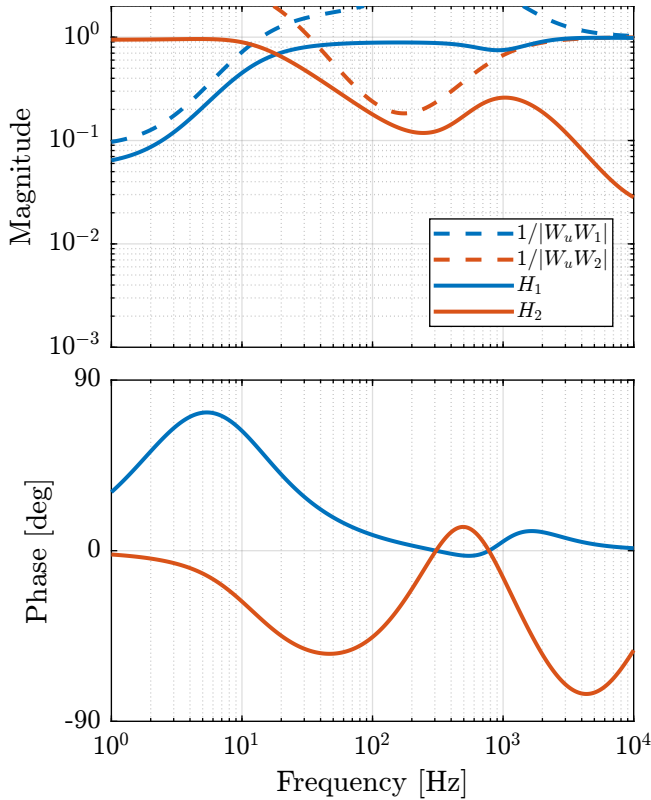

Fig. 23. Obtained complementary filters after mixed $\mathcal{H}_2/\mathcal{H}_\infty$ synthesis

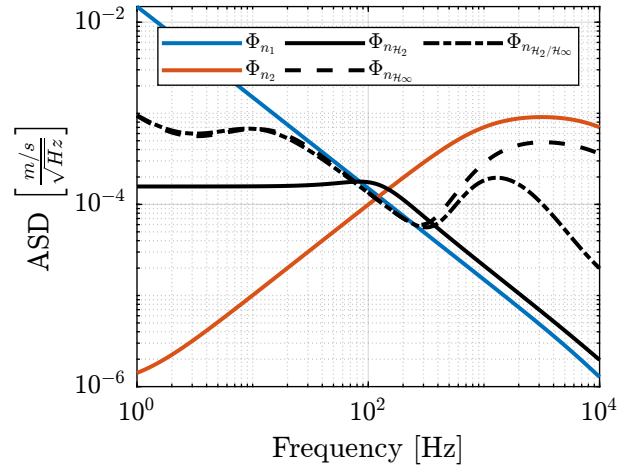

Fig. 24. Power Spectral Density of the Super Sensor obtained with the mixed $\mathcal{H}_2/\mathcal{H}_\infty$ synthesis

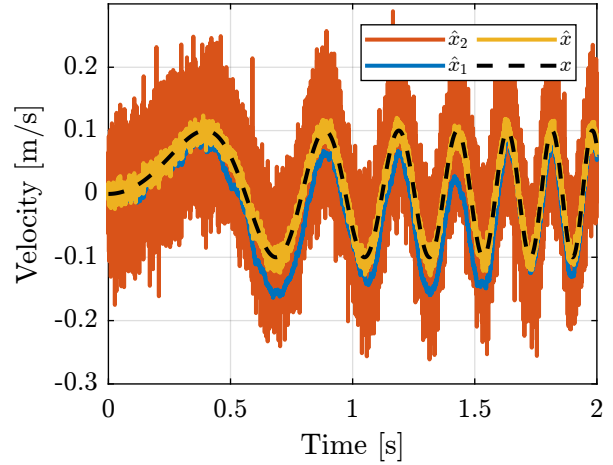

Fig. 25. Noise of individual sensors and noise of the super sensor

D. Example

V. EXPERIMENTAL VALIDATION

A. Experimental Setup

B. Sensor Noise and Dynamical Uncertainty

C. Mixed $\mathcal{H}_2/\mathcal{H}_\infty$ Synthesis

D. Super Sensor Noise and Dynamical Uncertainty

VI. CONCLUSION

VII. ACKNOWLEDGMENT

REFERENCES

- [1] M. Zimmermann and W. Sulzer, "High bandwidth orientation measurement and control based on complementary filtering," *Robot Control* 1991, pp. 525–530, 1992. [Online]. Available: <https://doi.org/10.1016/b978-0-08-041276-4.50093-5>
- [2] P. Corke, "An inertial and visual sensing system for a small autonomous helicopter," *Journal of Robotic Systems*, vol. 21, no. 2, pp. 43–51, 2004. [Online]. Available: <https://doi.org/10.1002/rob.10127>
- [3] H. G. Min and E. T. Jeung, "Complementary filter design for angle estimation using mems accelerometer and gyroscope," *Department of Control and Instrumentation, Changwon National University, Changwon, Korea*, pp. 641–773, 2015.

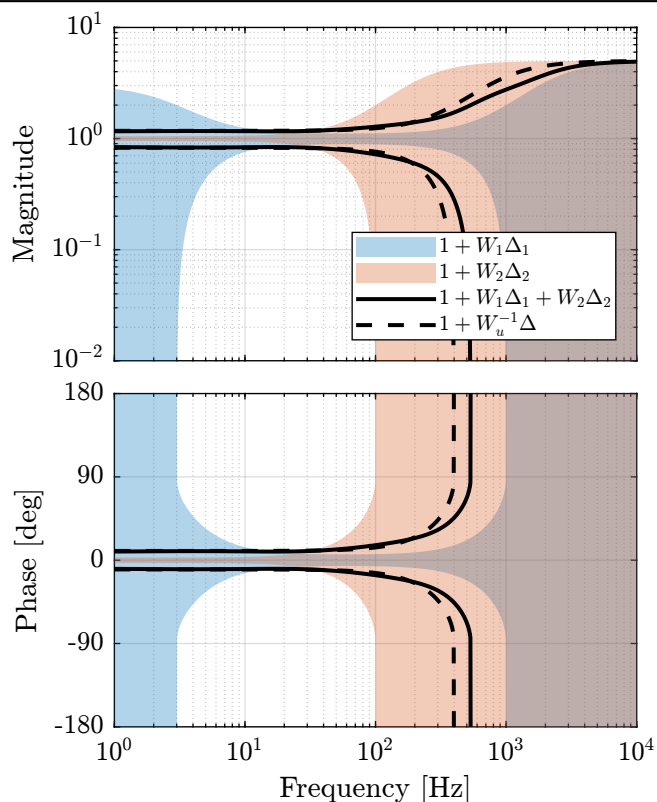

Fig. 26. Super sensor dynamical uncertainty (solid curve) when using the mixed $\mathcal{H}_2/\mathcal{H}_\infty$ Synthesis

- [4] F. Shaw and K. Srinivasan, "Bandwidth enhancement of position measurements using measured acceleration," *Mechanical Systems and Signal Processing*, vol. 4, no. 1, pp. 23–38, 1990. [Online]. Available: [https://doi.org/10.1016/0888-3270\(90\)90038-m](https://doi.org/10.1016/0888-3270(90)90038-m)
- [5] F. Matichard, B. Lantz, R. Mittleman, K. Mason, J. Kissel, B. Abbott, S. Biscans, J. McIver, R. Abbott, S. Abbott *et al.*, "Seismic isolation of advanced ligo: Review of strategy, instrumentation and performance," *Classical and Quantum Gravity*, vol. 32, no. 18, p. 185003, 2015.
- [6] W. Hua, D. B. Debra, C. T. Hardham, B. T. Lantz, and J. A. Giaime, "Polyphase fir complementary filters for control systems," in *Proceedings of ASPE Spring Topical Meeting on Control of Precision Systems*, 2004, pp. 109–114.
- [7] C. Collette and F. Matichard, "Sensor fusion methods for high performance active vibration isolation systems," *Journal of Sound and Vibration*, vol. 342, no. nil, pp. 1–21, 2015. [Online]. Available: <https://doi.org/10.1016/j.jsv.2015.01.006>
- [8] A. Jensen, C. Coopmans, and Y. Chen, "Basics and guidelines of complementary filters for small uas navigation," in *2013 International Conference on Unmanned Aircraft Systems (ICUAS)*, 5 2013, p. nil. [Online]. Available: <https://doi.org/10.1109/icuas.2013.6564726>
- [9] W. Hua, "Low frequency vibration isolation and alignment system for advanced ligo," Ph.D. dissertation, stanford university, 2005.
- [10] R. Mahony, T. Hamel, and J.-M. Pfimlin, "Nonlinear complementary filters on the special orthogonal group," *IEEE Transactions on Automatic Control*, vol. 53, no. 5, pp. 1203–1218, 2008. [Online]. Available: <https://doi.org/10.1109/tac.2008.923738>
- [11] A. Pascoal, I. Kaminer, and P. Oliveira, "Navigation system design using time-varying complementary filters," in *Guidance, Navigation, and Control Conference and Exhibit*, 1999, p. nil. [Online]. Available: <https://doi.org/10.2514/6.1999-4290>
- [12] R. G. Brown, "Integrated navigation systems and kalman filtering: a perspective," *Navigation*, vol. 19, no. 4, pp. 355–362, 1972. [Online]. Available: <https://doi.org/10.1002/j.2161-4296.1972.tb01706.x>